

ziehend (z) / pull (z)

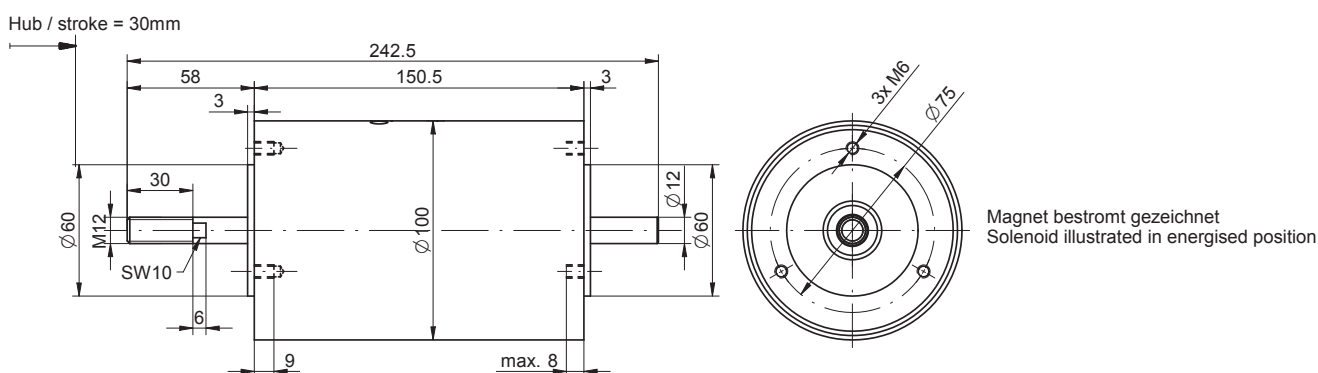

stossend (s) / push (s)

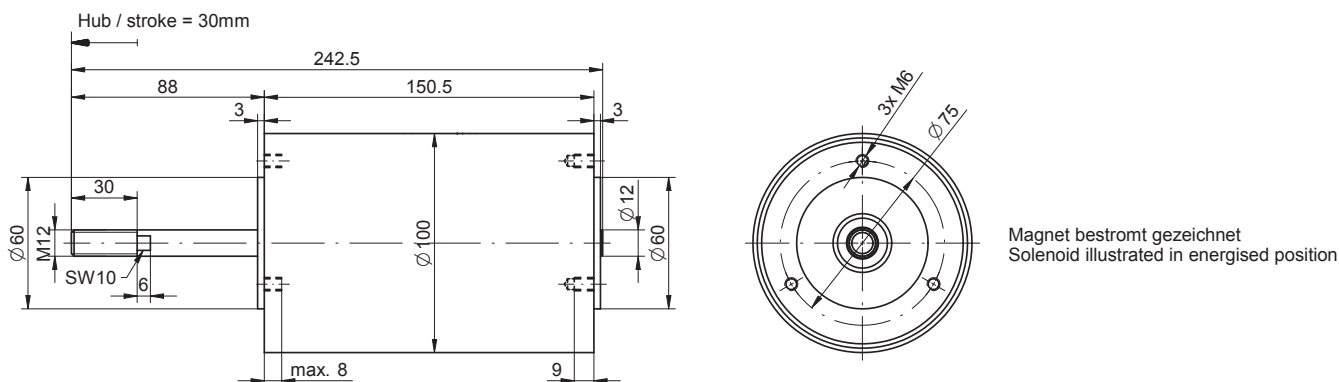

Optionen: Flansch (l) / Rückstellfeder (F) / Schutzart IP65
 Options: flange (l) / return spring (F) / degree of protection IP65

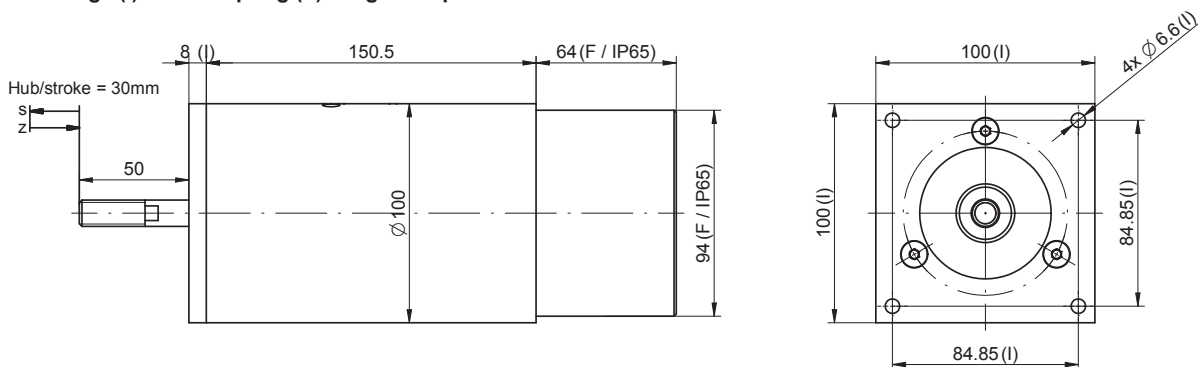

Elektrischer Anschluss: Steckanschluss (S) / Electrical termination: Plug and socket connection (S)

ziehend (z) / pull (z)

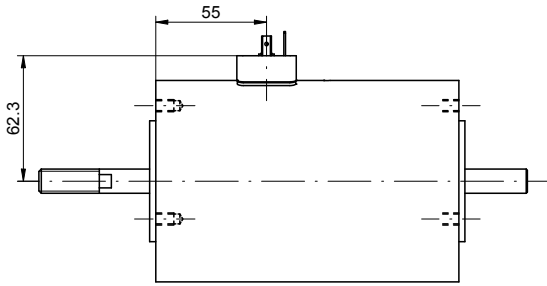

stossend (s) / push (s)

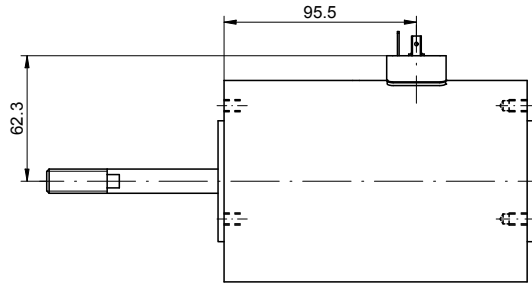

ohne Gleichrichter (schwarz) / without rectifier (black) (max. 16A)
 mit Gleichrichter (transparent) / with rectifier (transparent) (max. 1.5A)

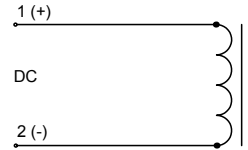
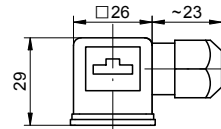
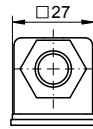
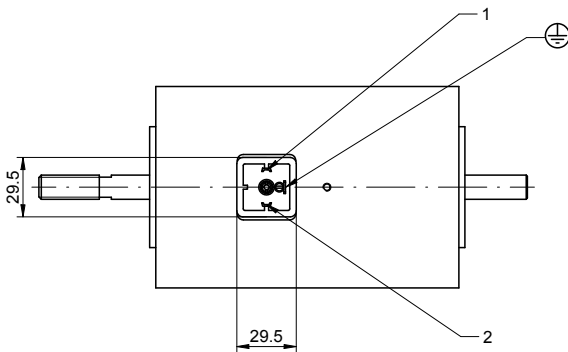

mit Gleichrichter / with rectifier (max. 6A)

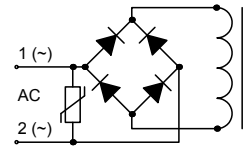
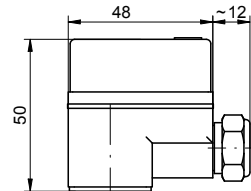
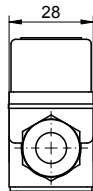

Elektrischer Anschluss: Klemmgehäuse (K) / Electrical termination: Terminal box (K)

ziehend (z) / pull (z)

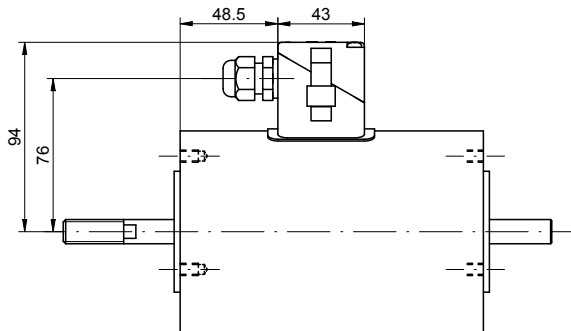

stossend (s) / push (s)

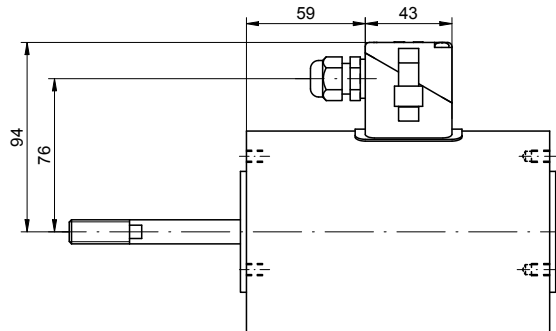

ohne Gleichrichter / without rectifier (max. 16A)

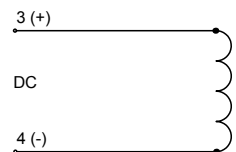
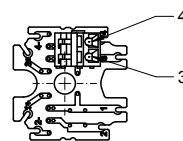

mit Gleichrichter / with rectifier (max. 2A)

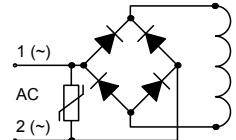
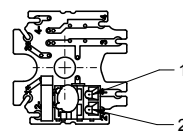

Elektrischer Anschluss: Litzenanschluss (W) / Electrical termination: Lead wires (W)

ziehend (z) / pull (z)

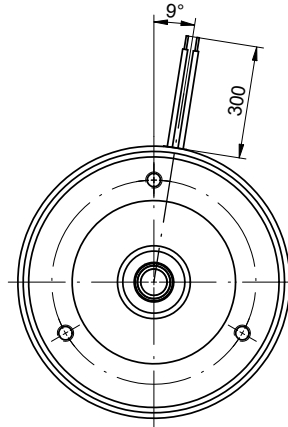
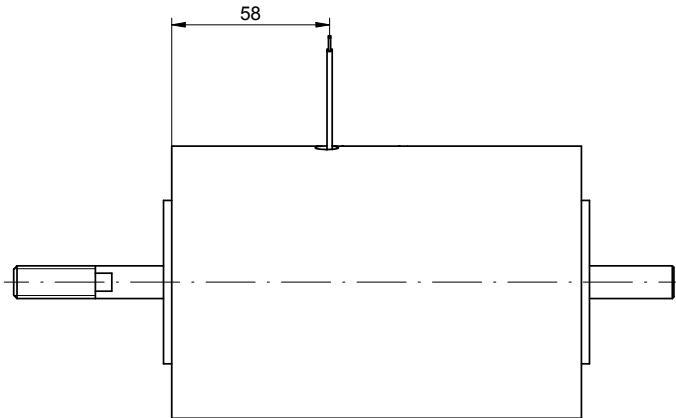

stossend (s) / push (s)

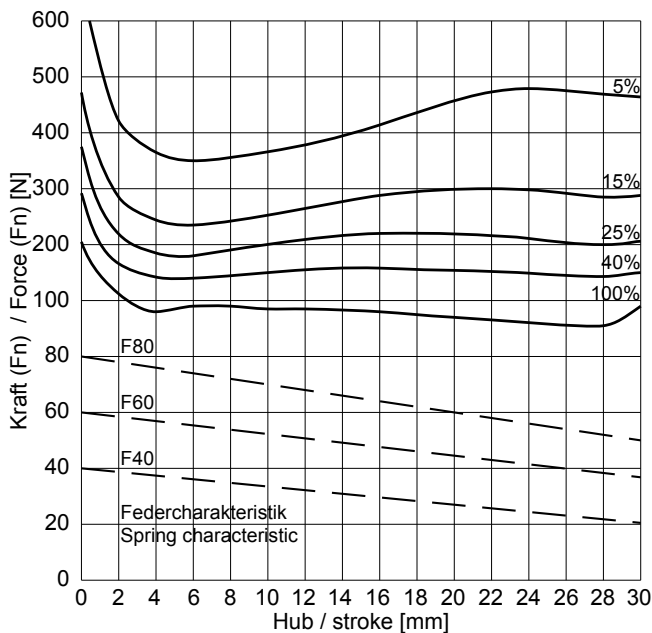
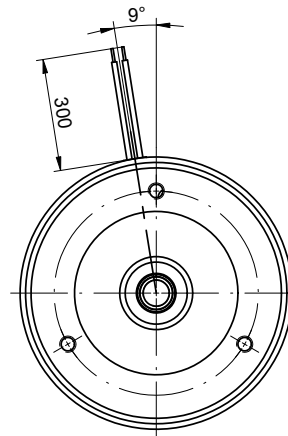
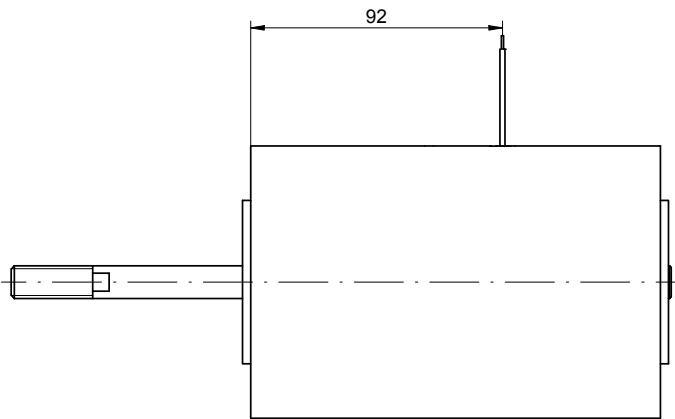

ED [%]	100	40	25	15	5	Duty cycle [%]
Die Spieldauer für die Berechnung der Einschaltdauer beträgt 300 sec.						The max. duty cycle time to determine the duty cycle is 300 sec.
Hubarbeit [Ncm]	273	420	540	705	1050	Work done [Ncm]
El. Leistung [W] (P20)	53	123	209	315	826	Power [W] (P20)
Anzugszeit [ms] Abfallzeit [ms]	407 271	471 141	499 121	471 109	260 97	Operating time [ms] Release time [ms]
(+20°C, betriebswarm, bei Belastung mit 70% der entsprechenden Magnetkraft)						(+20°C, operating temperature, with a load equal to 70% of the solenoid force)

■ = Nicht Standard / not standard

Spezifikationen

Specifications

Funktion	ziehend / stossend	pull / push	Operation
Vorzugs-Nennspannung	24 VDC (max. 230 VAC)		Preferred rated voltage
Isolierstoffklasse	B (130°C) DIN VDE 0580		Class of insulation
Prüfspannung Überspannungskategorie	EN 60664-1 III		Test voltage Surge category
Schutzart Litzenanschluss W Steckanschluss S Klemmgehäuse K	IP20 (IEC 60529) IP40; max. IP65 (IEC 60529) IP40; max. IP65 (IEC 60529)		Degree of protection Lead wire W Plug and socket connection S Terminal box K
El. Anschlussart	Litzen (300 mm), AWG20 Steckanschluss DIN-175301-803 Klemmgehäuse	Lead wires (300 mm), AWG20 Plug and socket connection DIN-175301-803 Terminal box	Electrical termination
Oberflächenbehandlung	schwarz lackiert	black varnished	Surface treatment
Bewegte Masse	0.960 kg		Moving mass
Total Magnetgewicht	7.550 kg		Total weight of solenoid

Bestellbeispiel

Gleichstrom-Industrie-Magnet

z: ziehend
s: stossend

Durchmesser des Magneten [mm]

Nennhub des Magneten [mm]

Einschaltdauer (ED) [%]

W: Litzenanschluss

S: Steckanschluss

K: Klemmgehäuse

Spannung [V]

I mit Flansch

III ohne Flansch

Mit Gleichrichter (**S** oder **K**)

Ohne Gleichrichter kein Index

Mit Rückstellfeder

Ohne Rückstellfeder kein Index

Index der Federkennlinie

Erhöhte Schutzart (**S** oder **K**)

Ohne erhöhte Schutzart kein Index

GIz - 100.30 - 100 S - 230 I G F60 IP65

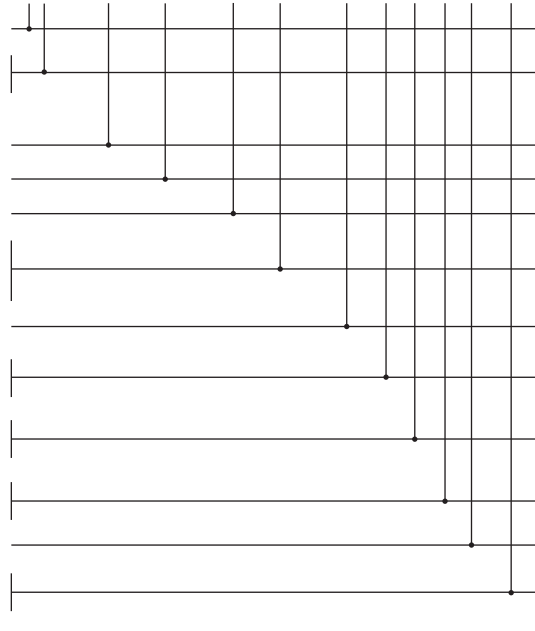

Ordering specification

Type **GI**: D.C. Industrial Solenoid

z: pull
s: push

Diameter of solenoid [mm]

Rated stroke of solenoid [mm]

Duty cycle [%]

W: Lead wire

S: Plug and socket connection

K: Terminal box

Voltage [V]

I with flange

III without flange

With rectifier (**S** or **K**)

without rectifier - no index

With return-spring assembly

without spring - no index

Index of return-spring

Higher degree of protection (**S** or **K**)

without higher degree of protection - no index

Bemerkungen

- Magnete hergestellt und geprüft nach DIN VDE 0580
- Magnetkraft betriebswarm gemessen bei 20°C Umgebungstemperatur, waagrechter Bewegungsrichtung mit 90% Nennspannung
- Die Magnethaftkraftwerte gelten nur als Referenzwerte und können infolge Toleranzen um ±10% abweichen
- Sonderausführungen sind lieferbar
- Änderungen vorbehalten - Abbildungen unverbindlich
- RoHS konform, frei von Halogenen (PVC)
- Unsere „Technischen Erläuterungen“ geben Auskunft über den Einsatz von Magneten sowie zu allgemeinen Montage- und Sicherheitshinweisen

Notes

- Solenoids manufactured and tested according to DIN VDE 0580
- Forces indicated measured at 20°C ambient and operating temperature with 90% of its rated voltage, in horizontal position
- Force values for reference only and can differ ±10% as a result of natural dispersion
- Special designs are available
- All specifications subject to change without notice
- Compliant with RoHS; free of halogenes (PVC)
- Our „Technical Explanations“ provide information about the use of solenoids as well as to general installation and safety instructions